

Elevação

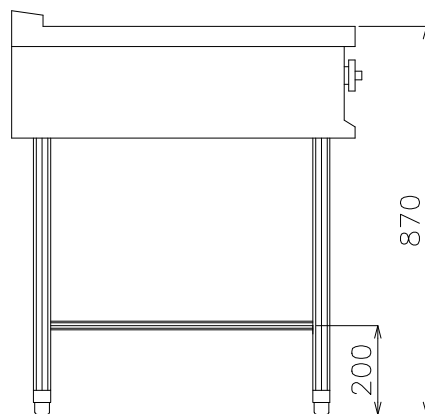

Lateral

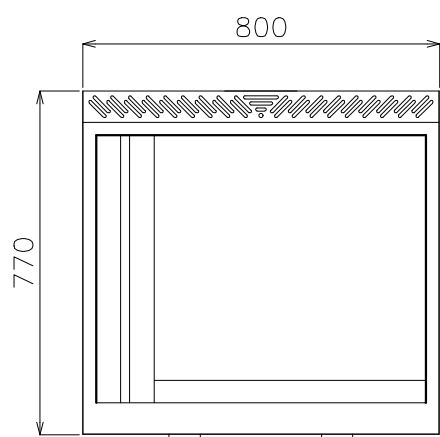

Planta

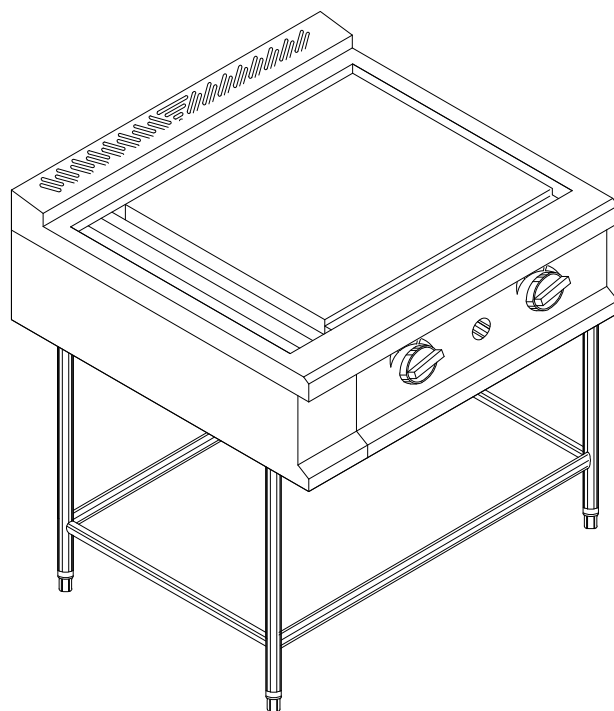

CHAPA QUENTE A GÁS 800
ESTRUTURA INFERIOR EM TUBO INOX 304
MEDIDAS: 800X770X870mm
CONSUMO: 3,4 kg/h
ESTE EQUIPAMENTO PODE TAMBÉM SER DE SOBREPOR, SEM A ESTRUTURA INFERIOR